



Introduction	3
Product features and benefits	4
Package contents	5
Dimensions	6
Versatile - compatible bike styles	7
Setting-out suggestions	9
Installation	11
Drilling template	14

## Introduction



### CYCLOC

#### Store your bike with style

Cycloc's unique ability to carefully combine considered thought with a twist of poetic spirit to create a range of simple, playful and practical products has earned it global recognition with numerous awards and accolades.

Founded in 2006, Cycloc operates from their design studio in London's creative East End and a manufacturing facility in the UK. A team of skilled and enthusiastic distributors and retailers provide support globally.

### HERO

#### Platform pedal mounted cycle display.

- Versatile - store bikes horizontally in left or right orientations.
- Facility to lock bike in place.
- Ideal for all bikes: children's, ladies, gents and tandems.
- Perfect for home, office or retail display.
- Make efficient use of space with a tiered installation.
- Ideal for bikes with platform pedals.
- Discreet wheel rests protect walls from dirt and damage.
- Available in 6 bright colours.

*'...makes the bike look like a heroic piece of installation art'*

*slowtwitch.com*



**Product features and benefits**

**Main support unit**

Two large flanged fixings secure HERO to wall

Oval opening accommodates platform and clipless pedals

Oval opening accommodates conventional bicycle lock

Inclined oval profile automatically aligns pedal for bike support

Opening allows large pedals to protrude

Insert panel hides fixings

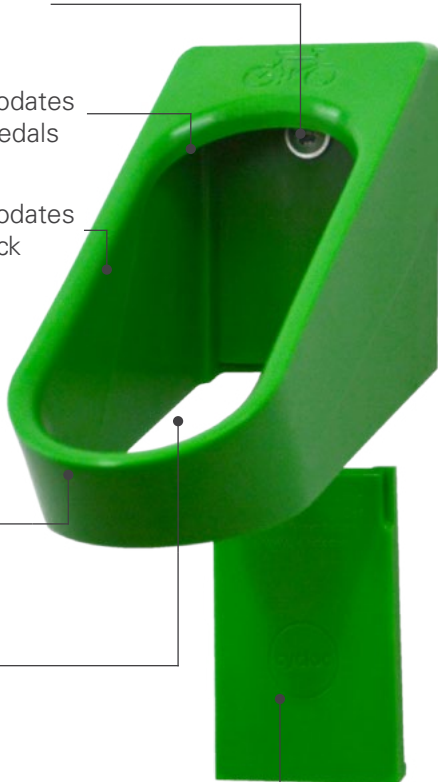

**Wheel support x2**

Protects wall from dirt and damage

Ensures bike is aligned horizontally

Prevents front wheel and handlebars from turning

Large flanged fixings secure wheel supports to the wall

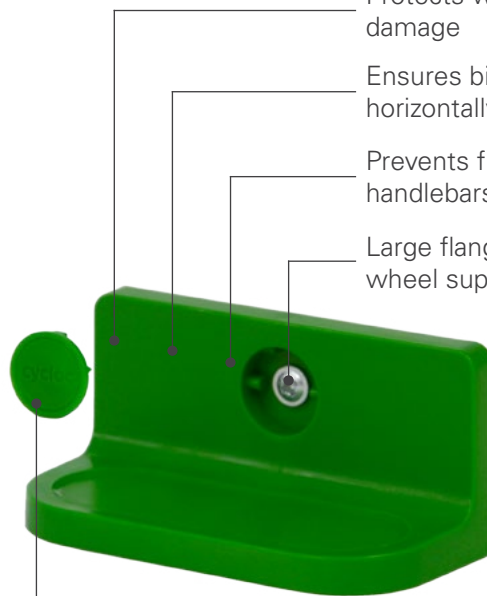

Insert panel hides fixing



Discreet wheel rest



Main pedal support

## Package contents

- x1 HERO main support unit
- x2 wheel supports
- x2 fixings + wall plugs for HERO main support unit
- x2 fixings + wall plugs for wheel supports
- x1 insert panel for HERO main support unit
- x2 insert panel for wheel supports



**Dimensions** (in mm)

HERO support

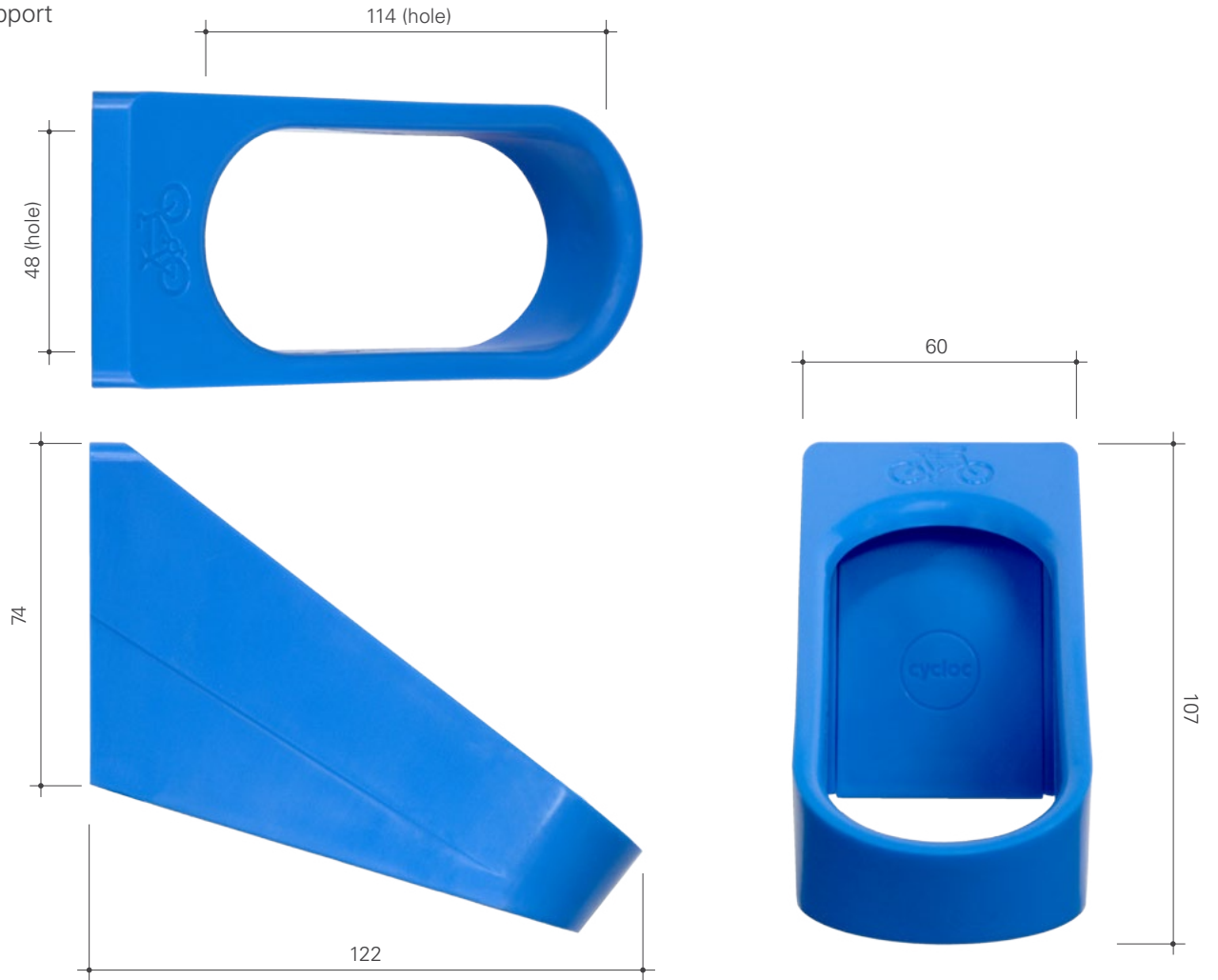

Wheel support x2

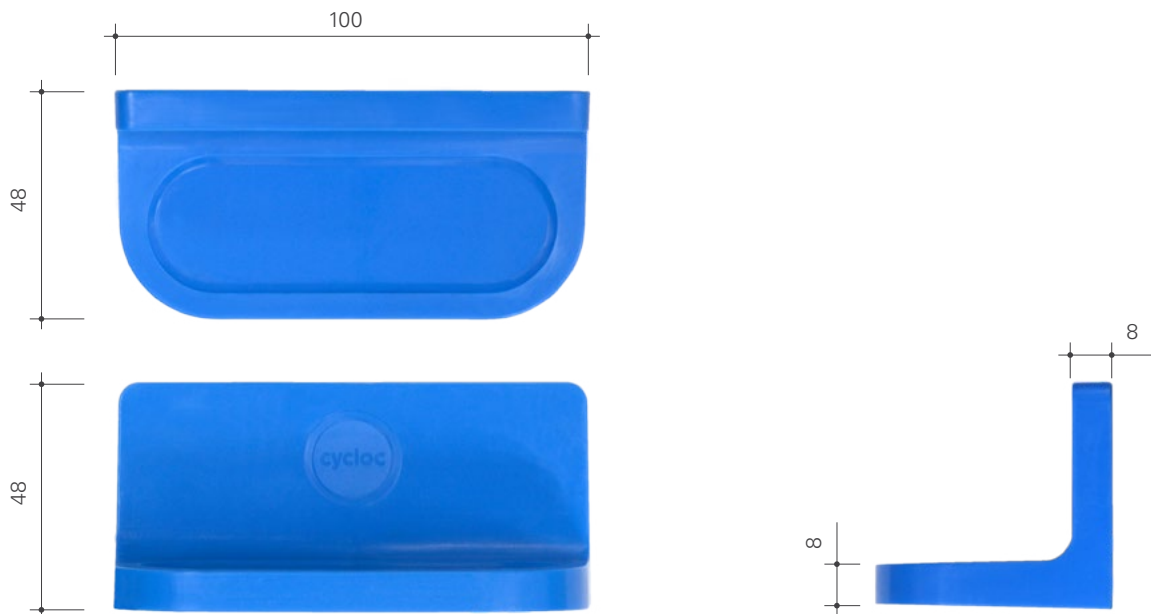

Versatile - compatible pedal styles



Platform standard or MTB

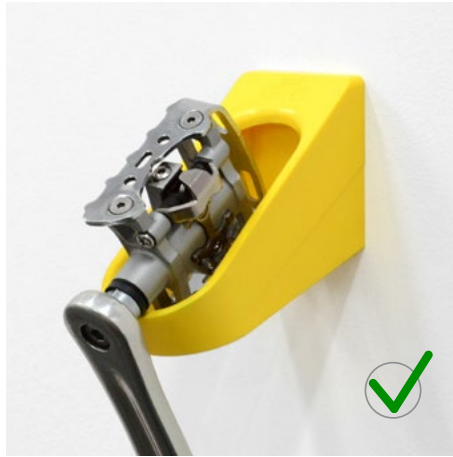

Platform SPD



Toe clip

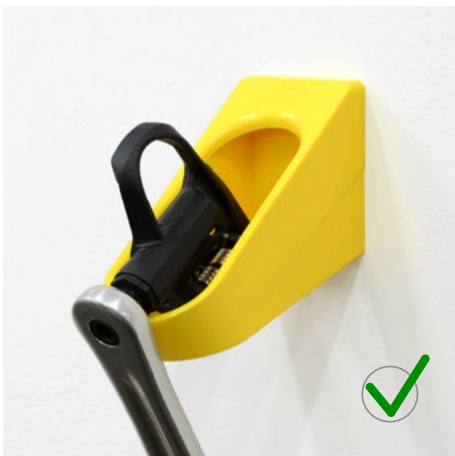

Clipless LOOK style

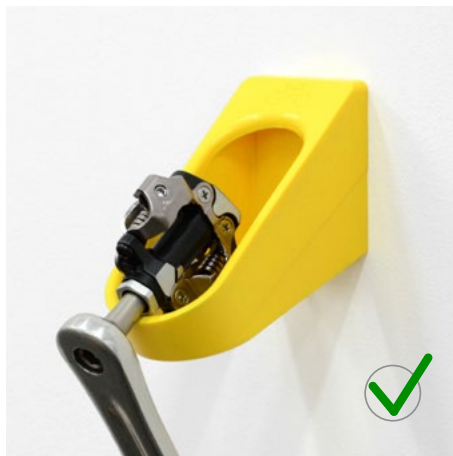

Clipless SPD

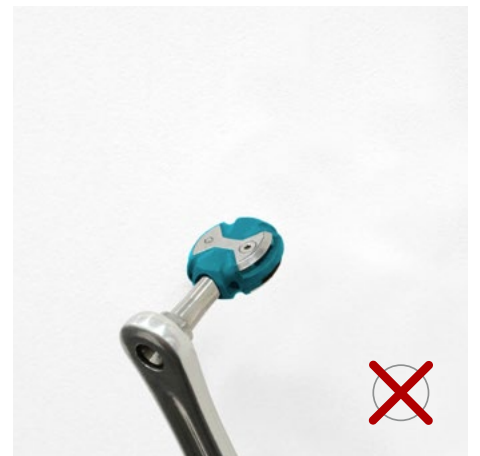

\*Clipless Speedplay



**SUPER  
HERO**<sup>™</sup>

\*Use Super Hero for Speedplay pedals.  
Also compatible with other clipless  
pedal system including Look and SPD.

Versatile - compatible bike styles



Mountain bikes



Mixte bikes



Small wheel bikes



Tandem bikes



Step-through bikes



Road bikes



Setting-out suggestions (in mm)



If using clipless pedals, please see Super Hero



MTB vertical separation can be minimized by staggering

Note: all dimensions are approximate and for guidance only. Your configuration may differ due to the following variables: crank length, bar width, wheel diameter, pedal width, bottom bracket height, stem rise and tyre width.

Setting-out suggestions (in mm)



Space between bikes



Bikes can be displayed facing left or right

## Installation

1. Please read these installation instructions thoroughly before commencing installation.
2. The Cycloc products were designed for use on a wall structure in good condition and suitably robust to carry the weight of the bike(s) to be hung from it. It is your responsibility to ensure that the product is installed on a suitable surface.
3. It should be noted that the maximum weights specified in the product guidance are static bike weights and do not allow for any dynamic loading, and are provided for guidance purposes only.
4. Sufficient expertise is required for the correct and safe installation of this product. It is your responsibility to ensure that the installer has a satisfactory working knowledge of the equipment required to achieve a robust and secure installation of the product, including the power tools and mechanical wall plug anchors to be used, and has the knowledge and skills required to determine whether the wall structure is suitable to carry the relevant weight.
5. If any of the above requirements are not complied with when installing the product, neither Cycloc nor Andrew Lang Product Design Ltd shall be liable or otherwise responsible for any damage to goods or injuries sustained because of the incorrect or inappropriate installation of Cycloc products.
6. For more information on product liability and the consequences of incorrect installation of Cycloc products, please refer to our Terms and Conditions, available at <https://cycloc.com/ps/content/3-terms-and-conditions>.

## Tools required



## Installation

### Main support

1



2



3



4



5



6



7



8



## Installation

### Wheel pad

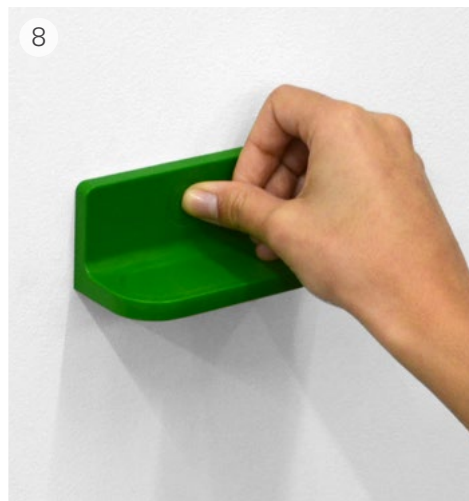
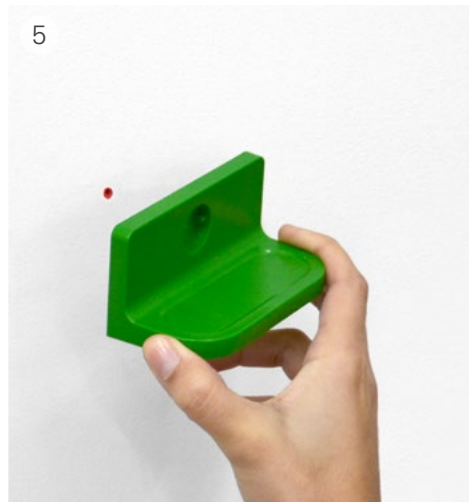
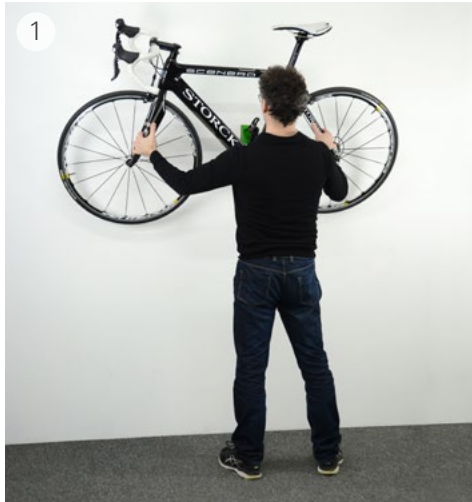

Drilling template (in mm)

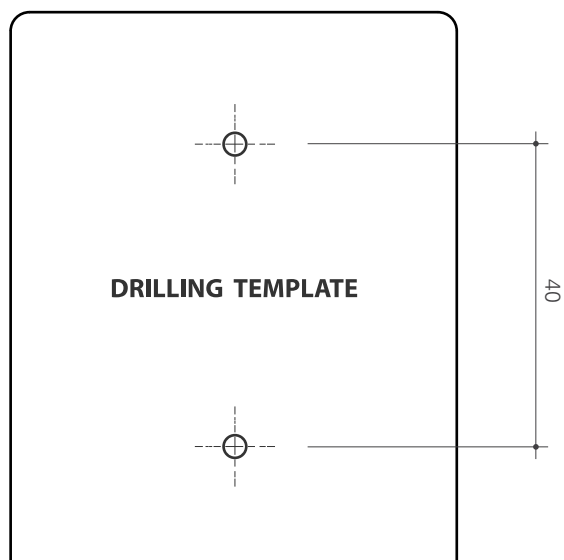

NOTE:

- To use template, this sheet must be printed on A4 paper.
- Dimension between two drilling points should be 40mm.